

► **Dynatube[®] Fittings for the Aerospace Industry**



Stratoflex Products Division



DANGER

FAILURE OR IMPROPER SELECTION OR IMPROPER USE OF THE PRODUCTS AND/OR SYSTEMS DESCRIBED HEREIN OR RELATED ITEMS CAN CAUSE DEATH, PERSONAL INJURY AND PROPERTY DAMAGE.

Before selecting or using any Parker hose or fittings or related accessories, it is important that you read and follow Parker Safety Guide for Selecting and Using Hoses, Fittings, and Related Accessories (Parker Publication No. 106-SG)

This document and other information from Parker Hannifin Corporation, its subsidiaries and authorized distributors, provide product and/or system options for further investigation by users having technical expertise. It is important that you analyze all aspects of your application and review the information concerning the product or system in the current product catalog. Due to the variety of operating conditions and applications for these products or systems, the user, through its own analysis and testing, is solely responsible for making the final selection of the products and systems and assuring that all performance, safety and warning requirements of the application are met.

The products described herein, including without limitation, product features, specifications, designs, availability and pricing, are subject to change by Parker Hannifin Corporation and its subsidiaries at any time without notice.

Offer of Sale

The items described in this document are hereby offered for sale by Parker Hannifin Corporation, its subsidiaries or its authorized distributors. This offer and its acceptance are governed by the provisions in the "Offer of Sale".

© 2007 Parker Hannifin Corporation



Parker Hannifin Corporation
Stratoflex Products Division
Jacksonville, Florida

Table of Contents

The Original “Beam Seal” Fitting.....	2
Benefits.....	3
Applications.....	4
Design Details	5 - 9
Typical Dynatube Fitting Configurations.....	10 - 13
Methods of Attachment.....	14 - 15
Test Programs.....	16
Engineering Support	16
Safety Guide.....	17 - 18
Offer of Sale.....	19

Dynatube[®] Fittings



The Original “Beam Seal” Fitting

Parker lightweight Dynatube fittings are designed for the high temperature, high pressure, no-leak requirements of aircraft and aerospace fluid and pneumatic systems. The Dynatube fitting is a metal-to-metal fitting providing significant savings in weight and envelope over all other types of aerospace fittings.

Dynatube has evolved from pioneering work on fittings for Teflon[®] hose assemblies, and was designed to meet high temperature, high pressure aerospace requirements. It has been updated and improved and its use has spread over the years as the aircraft and aerospace industry has grown and diversified, and as requirements have become more stringent.

The Dynatube fitting was originally selected for the demanding performance requirements of NASA’s Gemini and Apollo Space programs. These zero defect, full identification/traceability (I&T) programs provided a maturity of design to this new fitting in a very short time.

Teflon[®] is a registered trademark of E.I. du Pont Nemours and Company.

Thus the Dynatube traveled to the moon on the Apollo Lunar rocket and landed on the moon in Grumman’s Lunar Module in 1969.

In more recent times, the concept of a resilient, flexible metal seal augmented with a more rigid positive stop area has been imitated by several other companies and is generically referred to as “Beam Seal Fittings”. The high pressure, redundant sealing provided by Beam Seal Fittings has resulted in their near universal use in military aircraft under specifications SAE AS85421 and AS85720 (MIL-F-85421 and MIL-F-85720).

The Dynatube as the original Beam Seal Fitting has benefitted from literally thousands of tests and evolutionary refinements.

“Dynatube” is a registered trademark of Stratoflex Products Division, Parker Hannifin Corporation. Stratoflex acquired the Resistoflex Aerospace Division of Crane Aerospace in 2006. Dynatube fittings were invented in 1957.

Benefits

PROVEN PERFORMANCE

6.5 million Dynatube fittings flying on thousands of aircraft.

MINIMIZES FLIGHT DELAYS

Hydraulic reliability eases maintenance, saves time.

NO LEAKS

Dynamic seal design: sealing efficiency increases with higher pressures.

Anti-creep design: leak-proofness maintained through full temperature range.

LOW PROGRAM LIFE COST

The mechanical swaging method of tube attachment offers low cost assembly and inspection procedures for both original equipment and field repair.

LIGHTER

Significant weight savings over flared and flareless fittings, even the newest “light weight” flareless.

SMALLER

Nut and connector hexes same or smaller than equivalent flared and flareless sizes; shorter in axial length.

STRONGER

Greater structural strength than flared and flareless fittings.

NO LOOSENING

Insensitive to vibration — anti-creep design retains locking. High joint preload to resist nut loosening.

HIGH TEMPERATURE RATING

Lip seal construction withstands heat. Anti-creep design insures zero leakage under all thermal cycling conditions.

FIRE SAFETY

Withstands FAA zero flow 2000°F fire test. Withstands the low flow fire tests of AS85421 and AS85720.

TORQUE RESISTANCE

Primary seal independent of torquing effects, permitting extensive torque range.

EXTENDED SERVICE LIFE

Capable of sustaining 25 to 100 assembly and disassembly cycles without impairment of serviceability.

PROTECTED SEALING SURFACES

Due to controlled nut pull back dimensions. Truncated thread option allows maximum seal protection.

EASE OF INSTALLATION

Minimum protrusion of tube shoulder into connector means easy assembly of tubing, particularly short runs and straight lengths.



Applications

AEROSPACE

Dynatube fittings have been selected for a wide variety of hydraulic, fuel and pneumatic spacecraft applications beginning with the Gemini vehicle and have flown successfully in nearly every U. S. space endeavor since. Some of the Space Shuttle systems which employ Dynatube fittings are:

- Main Hydraulic System
- Lubrication System
- Reaction Control System
- Orbital Maneuvering System
- Environmental Control System
- Auxiliary Power Unit
- Solid Rocket Booster / Thrust Vector Control System

MILITARY AND COMMERCIAL AIRCRAFT

Dynatube fittings are used in such military and commercial aircraft as:

- Grumman.....F-14 Tomcat
- McDonnell Douglas.....F-15 Eagle
- Lockheed.....F-16 Falcon
- McDonnell Douglas.....F-18 Hornet
- Rockwell..... B-1 Lancer
- McDonnell Douglas..... AV8B Harrier II
- Lockheed..... L1011 Tristar
- Northrop.....B-2 Stealth Bomber
- Lockheed/Boeing..... F-22 Raptor
- Northrop..... F/A-18E/F Super Hornet
- Rolls Royce.....JSF Joint Strike Fighter
- Lockheed/Northrop.....JSF Joint Strike Fighter

IN SUMMARY:

Dynatube fittings are used in applications such as:

- Military Aircraft Fuel Systems
- Spacecraft (manned and unmanned)
- Helicopters
- Hydrofoils
- Jet Engine Fuel and Lube Systems
- Commercial Aircraft Fuel Systems
- Nuclear Reactors
- In-Flight Refueling Systems
- Missiles



Design Details

The Dynatube fitting consists of three components, compared to five in the MS fitting. This means only three potential leak paths for Dynatube, against four for the MS fitting.

The cross-section view details the seal in both unloaded and loaded conditions.

The description of the sealed process on page 6 explains why there is no leakage. Dynatube fittings meet or exceed the test requirements of SAE AS18280, AS85421 and AS85720 (MIL-F-18280, MIL-F-85421, and MIL-F-85720).

The chart below provides a material section guide based on available Dynatube fitting materials and maximum recommended system operating temperatures.

Note: Titanium is not recommended for gaseous or liquid oxygen systems.

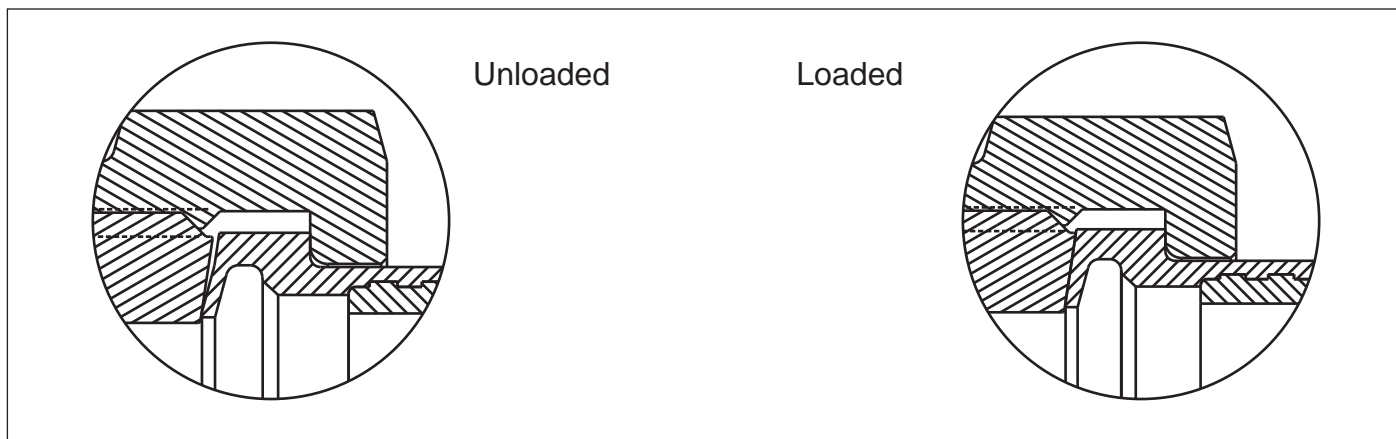
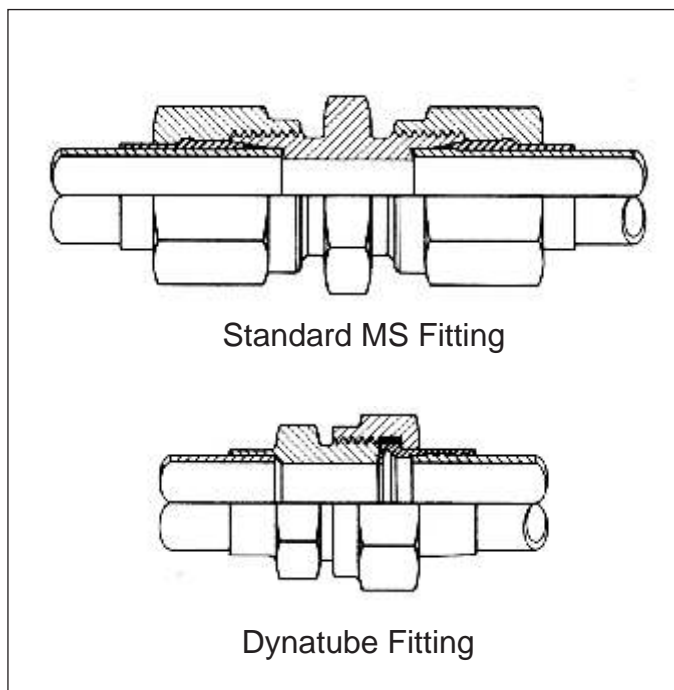

Material	Designation	Material Code	Specification	Operating Temp.
Titanium	6AL-4V STA	T	AMS 4965	-65°F to 650°F
Stainless Steel	17-4PH H1075	P	AMS 5643	-110°F to 650°F
Stainless Steel	15-5PH H1075	S	AMS 5659	-110°F to 650°F
Inconel*	Alloy 718	N	AMS 5663	-320°F to 1300°F

*Trademark

Design Details

The Dynatube fitting at the right is shown in the finger-tight configuration before deflection of the cantilever beam. Starting at low torque values, the pressure seal is formed at the inner edge of the beam.

Continuing to tighten the nut brings the angled surface of the male connector into contact with the outer rim (stop area) of the shoulder. A secondary metal-to-metal seal is obtained at this outer edge. The beam portion of the shoulder continues to seal at its inner edge, and the Belleville spring action is available to help add a lock for the entire union, preventing loosening. The high pre-load forces built up in the fitting are parallel to the center line, which assures no collapse of one component into another or into the fluid stream. This also permits each area to serve its function without being subject to distortion from high coupling loads.

High strength materials are used in the design of the Dynatube fitting to achieve a spring like sealing force action of the beam, and to minimize weight and envelope. The use of these materials and the separation of seal and structural loads has greatly extended the permissible torque range of the fitting. This contributes to high torque retention and resistance to "creep". With the addition of solid film lubricant on all sliding surfaces (nut threads, male face and nut bearing shoulder), the Dynatube fitting is capable of being assembled and disassembled in excess of twenty-five times.

Dynatube fittings are used on aircraft hydraulic systems without need of safety wiring. Tests by NASA have shown the Dynatube to be highly resistant to loosening in high vibration rocket applications.

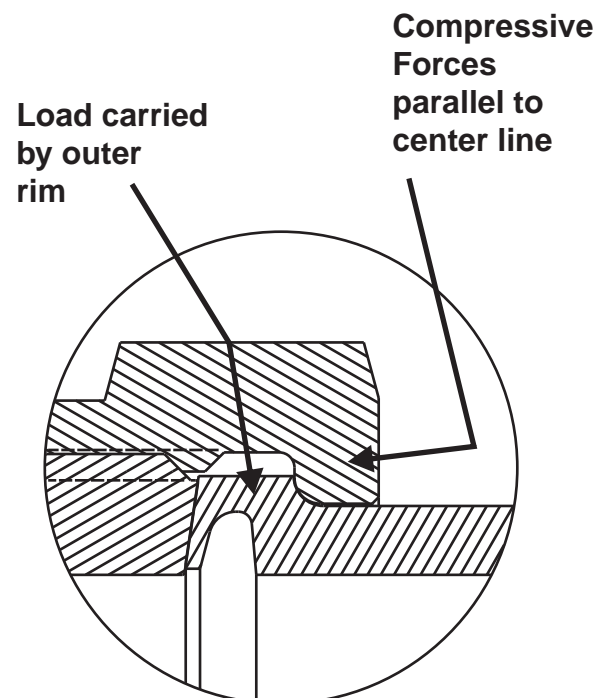
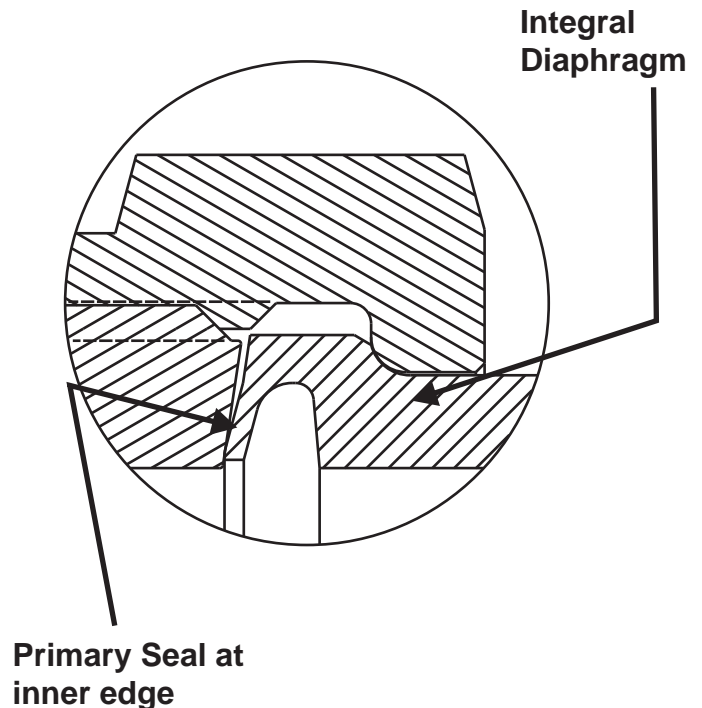

Design Details

The top drawing illustrates other important design features of the Dynatube fitting. Pressure boost reinforces the seal at higher pressures. The optional truncated or semi-thread permits complete damage protection for the seal during storage and installation. It also allows withdrawal of nut for fixturing of components, cooling of the beam during welding or other operations, and sideways insertion against the connector.

The bottom right drawing shows how the nut may be attached by use of a retaining wire.

The Dynatube design permits minimum separation clearance and tube deflection for assembly.

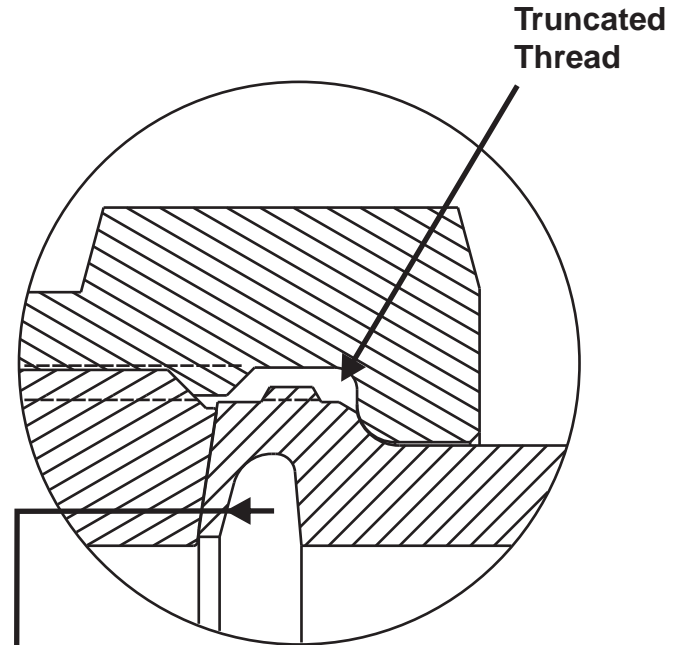

Pressure Boost

SLIP ON NUT

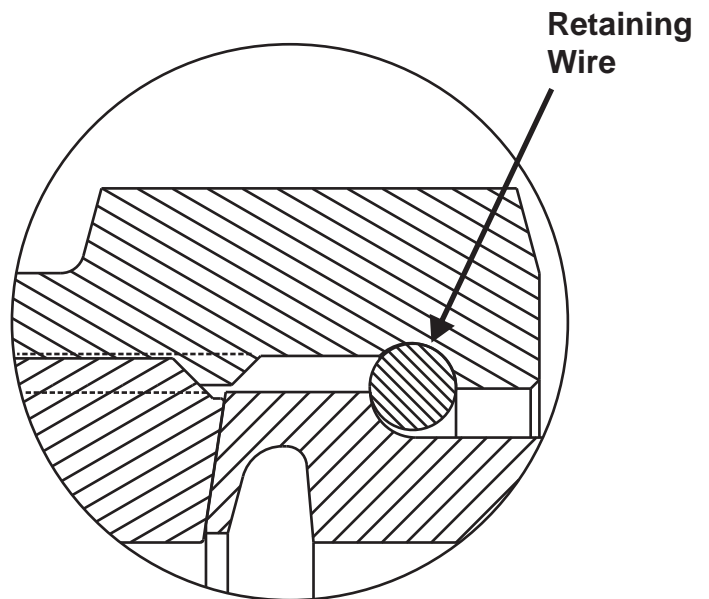

WIRED ON NUT

Dynatube[®] Fittings

Design Details

The Dynatube fitting uses an elegantly simple geometric design to produce a fitting that is easier to manufacture, inspect and use than its imitators.

The Dynatube fitting uses straight surfaces at precision angles to achieve concentrations of bearing stresses at the primary and secondary sealing areas.

Newer Beam Seal designs have had to use curved surfaces on their sealing faces to avoid infringing on the Dynatube patent. These fittings have surfaces which are geometrically complex and are thus difficult to produce and inspect.

The gently divergent angles used in the Dynatube actually produce a gradual intensification of compressive stress on the mating male fitting. This is not the case with the curved surface type of beam seal fittings. These fittings actually concentrate their contact forces over very narrow, sharply defined areas of the male and female fittings. This approach produces two distinct problems. They are more vulnerable to surface flaws since a very short radial scratch can extend across the entire primary or secondary sealing area. The highly concentrated loads produced by the primary seal on these fittings tends to "cut through" the bonded lubricant film on the male sealing surface and this adversely effects reusability.

Protrusion Advantages of Dynatube Fittings

Installation clearance or amount tubing must be sprung

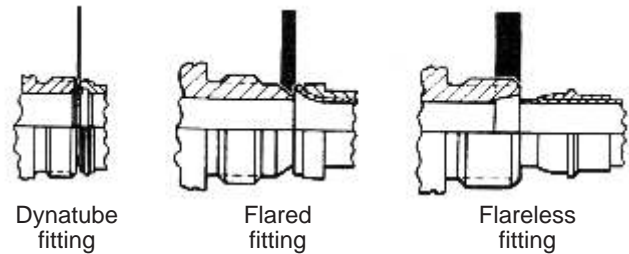

Protrusion Tables (inches)

Size	Dynatube fitting	Flared fitting	Flareless fitting
-3	.011	.068	.218
-4	.020	.071	.220
-5	.020	.069	.236
-6	.020	.080	.234
-8	.025	.097	.313
-10	.025	.096	.334
-12	.024	.125	.337
-16	.027	.129	.401
-20	.029	.177	.400
-24	.031	.165	.465

Weight Advantage of Dynatube Fittings

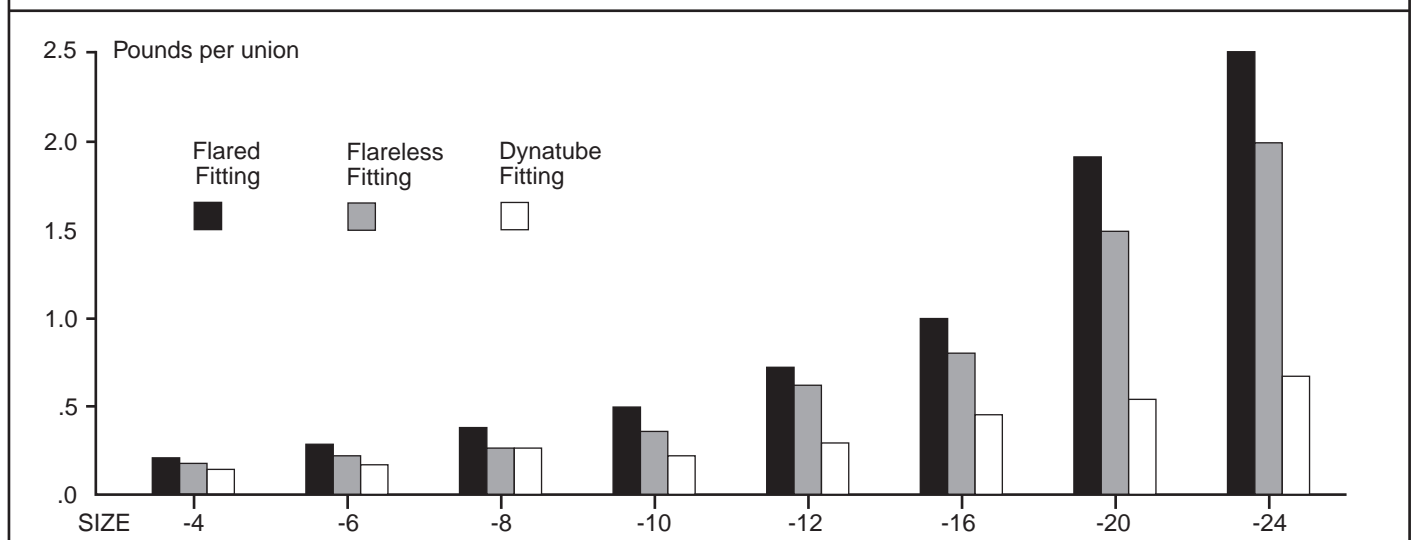

Design Details

As an example of weight distribution, provided by the Dynatube, analysis was made of a typical large aircraft which uses 1810 separate connections. Dynatube saved 506.7 pounds over flareless fittings and 622.7 pounds over the flared type.

Dynatube fittings are available in all standard shapes, connectors and reducers. Many special application fittings are available. Consult your Stratoflex representative for help in solving your plumbing problems.

Metric Dynatube fittings are available. They are designed specifically for use with metric tubing and contain preferred metric thread sizes. These fittings offer the same functional benefits as those produced in inch units.

Available in sizes from 5mm to 40mm, the metric Dynatube fitting uses recommended MJ threads per ISO/DIS 5855 and has been tested in accordance with AS85421 (MIL-F-85421).

Dynatube fittings are available in Metric Series with sizes and threads shown below:

Size	Metric THD	Torque (3000 psi)
-05	MJ10 x 1.0	7/14 N-M
-06	MJ12 x 1.25	14/20
-08	MJ14 x 1.5	17/25
-10	MJ16 x 1.5	20/34
-12	MJ18 x 1.5	27/41
-14	MJ20 x 1.5	34/60
-16	MJ22 x 1.5	47/73
-18	MJ24 x 1.5	54/82
-20	MJ27 x 1.5	68/96
-22	MJ30 x 1.5	82/109
-25	MJ33 x 1.5	101/129
-28	MJ36 x 1.5	122/150
-32	MJ39 x 1.5	149/191
-40	MJ50 x 2.0	176/218

*Notes:

1. Threads conform to MJ ISO 5855-3 dimensions for fluid system fittings.
2. Metric Dynatube fittings have R74000 series part numbers.

Dynatube Fitting Torque

Tube Size*	Thread	Torque for pressures up to 4000 psi, in.-lbs.	Torque for 5000 psi, in.-lbs.
03	.3750-28 UNJS	97/108	97/108
04	.4375-24 UNJS	151/168	151/168
05	.5000-24 UNJS	173/192	173/192
06	.5625-20 UNJS	270/300	270/300
08	.7188-20 UNJS	432/480	432/480
10	.8438-18 UNJS	594/660	720/890
12	1.0000-16 UNJ	756/840	840/960
14	1.1250-16 UNJ	918/1020	TBD
16	1.2500-14 UNJS	1242/1380	1620/1860
21	1.5781-14 UNJS	1512/1680**	N/A
25	1.8438-14 UNJS	1620/1800**	N/A

* For fittings which attach to tubing such as 1¼" or 1½" tube O.D., the fitting size would be 2120 and 2524 respectively. Sizes 20 and 24 are seldom used "Dynatube" seal face sizes and are not available for pressures over 300 psi or in Titanium. Fittings conforming to MIL-F-85421 and MIL-F-85720 use size 21 and 25, not size 20 or size 24 in the fitg part number.

**The -20 and -24 tube sizes are used for return line pressures. For the -20 size at 4000 psi, as used on the B-2, the torque is 1860 to 2400 in.-lbs.

Dynatube[®] Fittings

Typical Dynatube Fitting Configurations

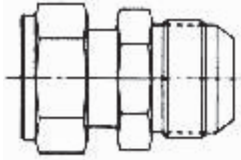

R27511
Pressure Test & Flushing Ftg.
Size to Size and Reducer
Dynatube to AN

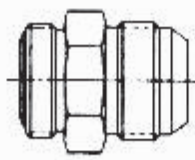

R27512
Pressure Test & Flushing Ftg.
Size to Size and Reducer
Dynatube to AN

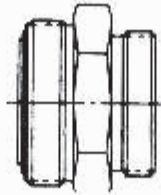

R27517
Pressure Test & Flushing Ftg.
Reducer
Dynatube Male to AS 930

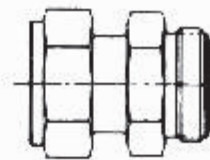

R27518
Pressure Test & Flushing Ftg.
Size to Size
Dynatube Female to Male

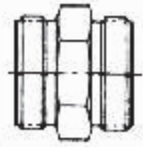

R44101 Connector

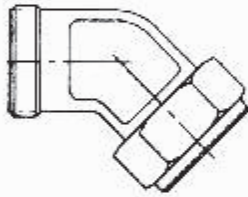

R44129-45 45° Elbow

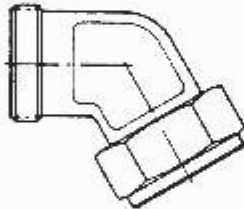

R44129-60 60° Elbow

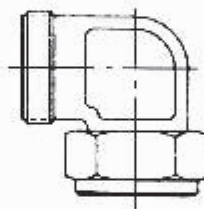

R44129-90 90° Elbow

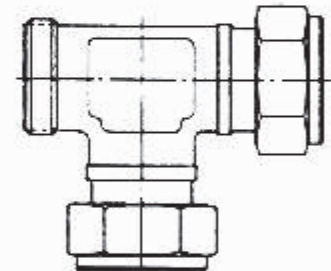

R44130 Tee

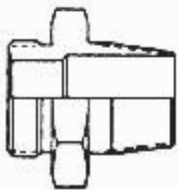

R44184 To Male Pipe

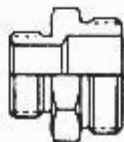

R44191 Expander to Port

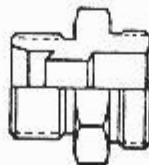

R44195 to MS

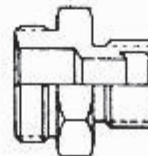

R44197 Reducer to MS

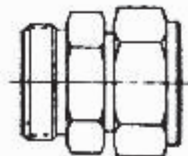

R44239 Connector

Example of Part No.

R44151P - XXW

Basic Part No. _____

Material _____

Finish _____

Add letter if safety wire holes required

W = 2 Wire Holes

U = 3 Wire Holes

Size _____

Typical Dynatube Fitting Configurations

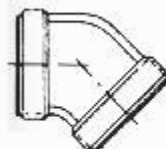

R44104 45° Elbow

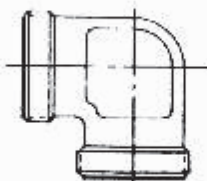

R44106 90° Elbow

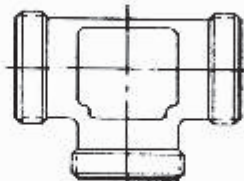

R44111 Tee

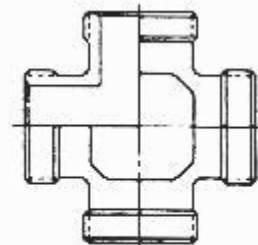

R44114 Cross

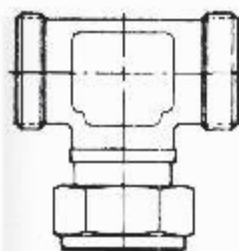

R44132 Tee

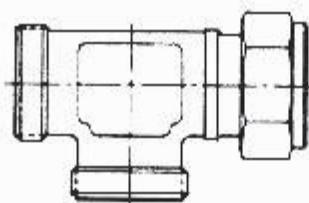

R44133 Tee

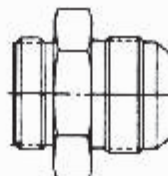

R44151 to AN

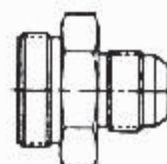

R44180 Reducer to AN

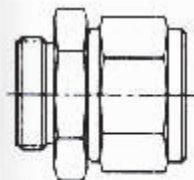

R44240 to AN Female

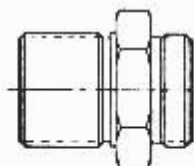

R44358 Connector with Bulkhead

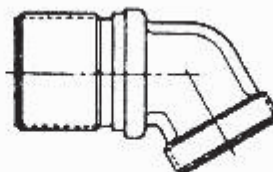

R44359 45° Elbow with Bulkhead

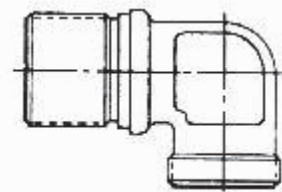

R44360 90° Elbow with Bulkhead

Example of Part No.

R44151P - XXW

Basic Part No. _____

Material _____

Finish _____

_____ Add letter if safety wire holes required

W = 2 Wire Holes

U = 3 Wire Holes

_____ Size

Dynatube® Fittings

Typical Dynatube Fitting Configurations



R44117 Cap



R44118 Jam Nut



R44119 Plug

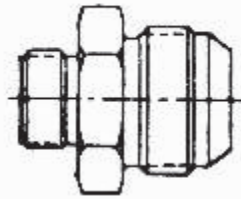

R44181 Expander to AN

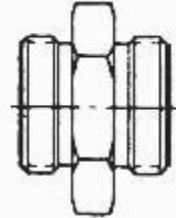

R44182 to Port

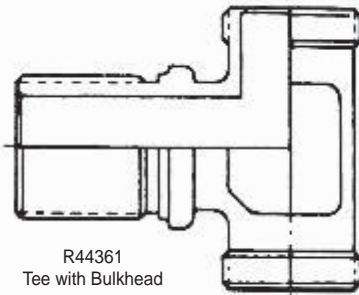

R44361
Tee with Bulkhead

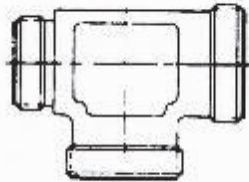

R45111 Tee Reducer

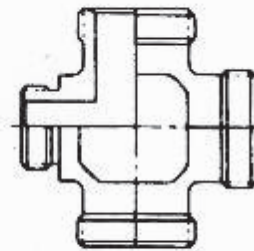

R45114 Cross Reducer

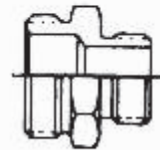

R45116 Reducer to Port

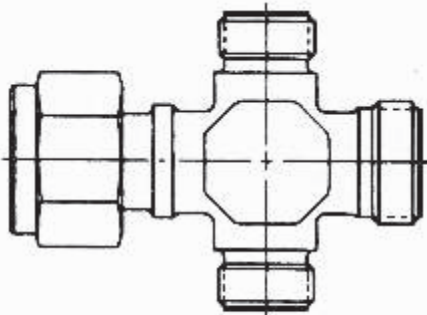

R45137 Cross Reducer

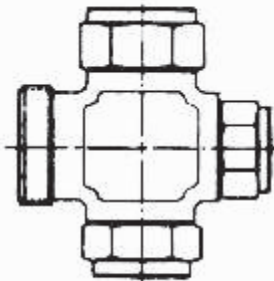

R45138 Cross Reducer

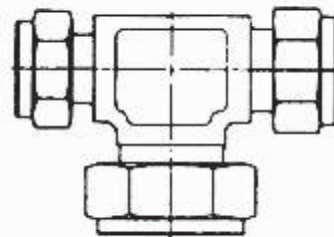

R451140 Tee Reducer

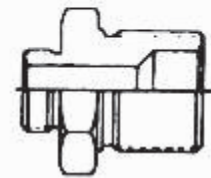

R451118 Bulkhead Reducer

Example of Part No.

R44151P - XXW

Basic Part No.

Material

Finish

Add letter if safety wire holes required

W = 2 Wire Holes

U = 3 Wire Holes

Size

Typical Dynatube Fitting Configurations

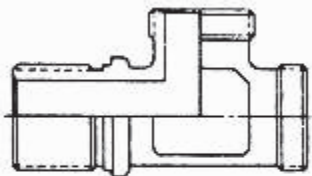

R44362 Tee with Bulkhead

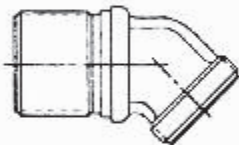

R44365 60° Elbow with Bulkhead

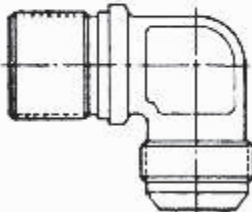

R44375 Tee, Bulkhead to AN

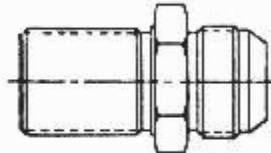

R44382 Bulkhead to AN

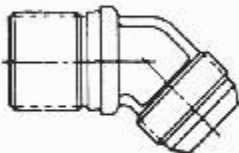

R44383 45° Elbow to AN

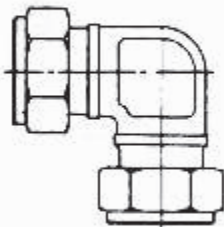

R44384 90° Elbow

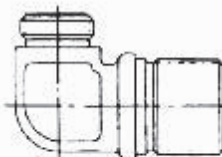

R45120 90° Elbow Reducer

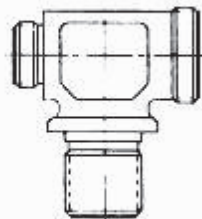

R45121 Tee Reducer

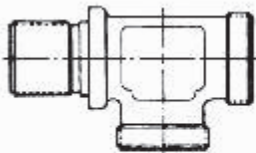

R45122 Tee Reducer

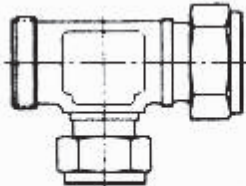

R45130 Tee Reducer

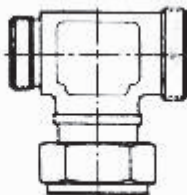

R45132 Tee Reducer

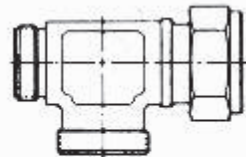

R45133 Tee Reducer

Example of Part No.

R44151P - XXW

Basic Part No.

Material

Finish

Add letter if safety wire holes required

W = 2 Wire Holes

U = 3 Wire Holes

Size

Methods of Attachment

The Dynatube fitting may be attached to rigid tubing by welding, brazing or mechanical swaging. For attachment to Teflon® hose, the permanently swaged method is used.

MECHANICAL INTERNAL SWAGING - This method is the most commonly used for attaching Dynatube fittings to tubing. It allows for attaching to tubing of any material with a modest investment in Stratoflex-developed tooling. The procedure is quick, extremely reliable and easy to inspect. It is qualified up to 8,000 psi.

BUTT-WELD - This method is favored for newer programs with titanium tubing. The butt-weld fitting provides a lighter, shorter fitting than mechanical internal swage fittings. Welding equipment of the microprocessor-controlled orbital design is required. Material welding compatibility between the tube and fitting is required. Fittings must also be coded for the tube wall thickness.

BRAZED CONNECTION - This method is used principally with stainless steel tubing. Brazed joints must be made with special Stratoflex designed chill blocks (R22584, typ) to protect the fitting from loss of strength from the high temperature. Brazed joints require extreme cleanliness and are usually monitored with x-ray inspection.

Attachment to Hose

For attachment to Teflon® hose the permanent swaged method is preferred and recommended. Approved to MIL-DTL-25579 for medium pressure and AS604, AS1339 and AS614 for high pressure.

Model A26699 Swaging Tool permits field fabrication of hose assemblies.

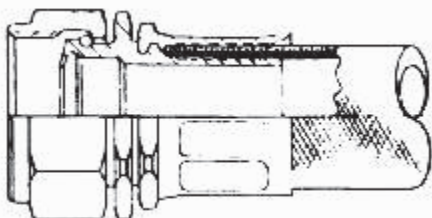

Methods of Attachment to Aluminum, Steel and Titanium Tubing

Mechanical-Internal Swaging

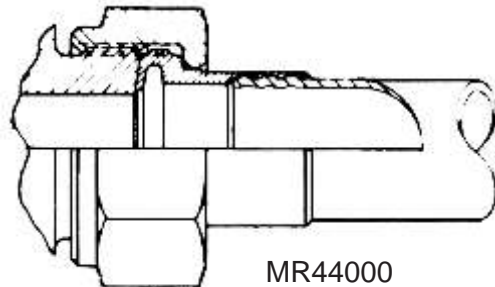

MR44000
Series
(17-4PH)

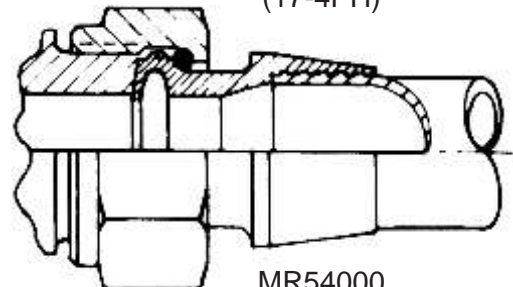

MR54000
Series
(Titanium)

Welding

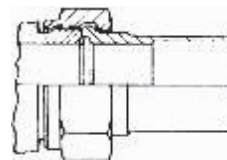

Standard Butt Weld
(Short and Long Shank)

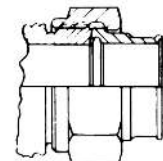

Integral T Butt Weld
(Short and Long Shank)

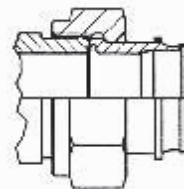

Retaining Nut
Integral T
Butt Weld

Brazing

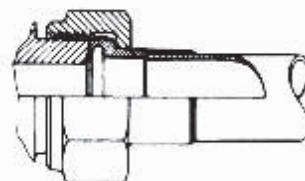

Methods of Attachment

The Dynatube fitting, using the swaging method, lends itself especially well for field repair. The small envelope of the tooling permits actual installation of fittings while on board the aircraft.

Here are typical tools recommended for field repair. Mechanical attachment of many materials is possible as shown in the chart.

Tube Materials for Mechanical Attachment

300 Series SS	3AL-2 1/2V Ti
21-6-9 SS	AM 350 SS
Aluminum Alloys All Tempers	Inco 625

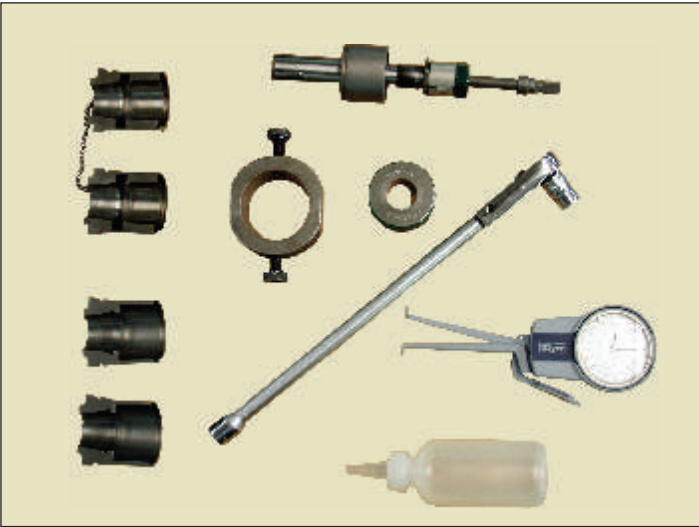

Typical tools for mechanical swaging



Tooling kit for field installation and repair



Hand assembly using socket wrench

Test Programs

Shown are some of the major programs for which Dynatube has been qualified from Gemini to the JSF.

Dynatube has been fire tested to ASI055 rigid tube requirements. The test data shown at the right supports the claim that Dynatube fittings on standard tubing will provide a fire-resistant system (5-minute exposure), and with heavier wall tubing in sizes 3/8 and 1/2 inch, would provide a fireproof system (15-minute exposure) in all sizes under a zero flow condition. This is far in excess of the requirements of AS85421 or AS85720.

Qualification Test Programs

- Grumman.....F-14 Tomcat
- McDonnell Douglas.....F-15 Eagle
- Lockheed.....F-16 Falcon
- McDonnell Douglas.....F-18 Hornet
- Rockwell.....B-1 Lancer
- McDonnell Douglas.....AV8B Harrier II
- Lockheed.....L1011 Tristar
- Northrop.....B-2 Stealth Bomber
- Lockheed/Boeing.....F-22 Raptor
- Northrop.....F/A-18E/F Super Hornet
- Rolls Royce.....JSF Joint Strike Fighter
- Lockheed/Northrop.....JSF Joint Strike Fighter

Engineering Support

Stratoflex maintains a library of several thousand published test reports. These reports range from broad Mil-Spec Type qualification tests to detailed investigations of narrow focused questions such as long term compatibility to a particular fluid.

Many of these reports are available to our customers and are provided at no cost as part of Stratoflex's engineering support.

To speak directly with one of our Product Engineers simply call and ask for the Engineering Department.

Fire Test Capabilities Zero Flow/Standard FAA 2000°F Flame/ 15-Minute Exposure

Dynatube Fitting on 321 Tubing

Size	Time to Leakage (minutes)
1/4 X .028	15†
3/8 X .042	8½*
1/2 X .042	6½*
5/8 X .058	15†
3/4 X .065	15†
1 X .095	15†

Internal pressure: 3000 psi

† No Failure

* Tubing ruptured in center

Above represents typical data. Other materials and sizes have been successfully tested.

Parker Safety Guide for Selecting and Using Hose, Tubing, Fittings and Related Accessories



DANGER: Failure or improper selection or improper use of hose, fittings, or related accessories can cause death, personal injury and property damage. Possible consequences of failure or improper selection or improper use of hose, fittings, or related accessories include but are not limited to:

- Explosion or burning of the conveyed fluid.
- Contact with conveyed fluids, hot, cold, toxic and injurious.
- Dangerously whipping hose.
- Loss of control system.
- High velocity fluid discharge.
- Fittings thrown off at high speed.
- Injection by high-pressure fluid discharge.

Before selecting or using any Parker Hose or Fittings or related accessories, it is important that you read and follow the instructions below.

1.0 GENERAL INSTRUCTIONS

- 1.1 Scope:** This safety guide provides instructions for selecting and using (including assembling, installing, and maintaining) hose (including all rubber *and/or* PTFE products commonly called "hose" or "tubing"), fittings (including all products commonly called "fittings" or "couplings" for attachment to hose), and related accessories (including crimping and swaging machines and tooling). This safety guide is a supplement to and is to be used with, the specific Parker publications for the specific hose, fittings and related accessories that are being considered for use.
- 1.2 Fail-Safe:** Hose and hose assemblies can and do fail without warning for many reasons. Design all systems and equipment in a fail-safe mode, so that failure of the hose or hose assembly will not endanger persons or property.
- 1.3 Distribution:** Provide a copy of this safety guide to each person that is responsible for selecting or using hose and fitting products. Do not select or use hose and fittings without thoroughly reading and understanding this safety guide as well as the specific Parker publications for the products considered or selected.
- 1.4 User Responsibility:** Due to the wide variety of operating conditions and uses for hose and fittings, Parker and its distributors do not represent or warrant that any particular hose or fitting is suitable for any specific end use system. Most Parker Stratoflex Products Division products are qualified to Military or Industry Standards. This safety guide does not analyze all technical parameters that must be considered in selecting a product. The user, through its own analysis and testing, is solely responsible for:
- Making the final selection of the hose and fitting.
 - Assuring that the user's requirements are met and that the use presents no health or safety hazards.
 - Providing all appropriate health and safety warnings on the equipment on which the hose and fittings are used.
- 1.5 Additional Questions:** Call the appropriate Parker technical service department if you have any questions or require any additional information. See the Parker publication for the product being considered or used, for telephone numbers of the appropriate technical service department.

2.0 HOSE AND FITTING SELECTION INSTRUCTIONS

- 2.1 Electrical Conductivity:** Certain applications require that a hose be nonconductive to prevent electrical current flow or maintain electrical isolation. Other applications require the hose to be sufficiently conductive to drain off static electricity; this is typical of rubber hose and of all aerospace fuel, oil and hydraulic PTFE hose. Extreme care must be exercised when selecting hose and fittings for these or any other applications in which electrical conductivity or non-conductivity is a factor.
- For applications that require hose to be electrically nonconductive, only special nonconductive hose can be used. The manufacturer of the equipment in which the nonconductive hose is to be used must be consulted to be certain that the hose and fittings that are selected are proper for the application. Do not use any Parker hose or fitting for any such application requiring nonconductive hose unless (i) the application is expressly approved in the Parker technical publication for the product, (ii) the manufacturer of the equipment on which the hose is to be used specifically approves the particular Parker hose and fitting for such use.
- The electrical conductivity or non-conductivity of hose and fittings is dependent upon many factors and may be susceptible to change. These factors include but are not limited to the various materials, including fitting finish, used to make the hose and the fittings, how the fittings contact the hose, age and amount of deterioration of damage or other changes and other factors. Aluminum fitting finish effects "conductivity"; anodize is non-conductive, while alodine is conductive.
- 2.2 Pressure:** Hose selection must be made so that the published maximum recommended working pressure of the hose is equal to or greater than the maximum system pressure. Surge pressures in the system higher than the published maximum recommended working pressure would cause failure or shorten hose life. Do not confuse burst pressure or other pressure values with working pressure and do not use burst pressure or other pressure values for this purpose.

Hose assemblies are "proof pressure" tested (normally 2 x working rated pressure) to confirm proper fabrication of the assembly. Gaseous test, including air-under-water, shall be at rated working pressure only and see 4.7 caution below. Care must be exercised to prevent water, or other fluid contaminants from unnecessarily contacting reinforcement, etc.

- 2.3 Suction:** Hoses used for suction applications must be selected to insure that the hose will withstand the vacuum and pressure of the system. Improperly selected hose may collapse in suction application.
- 2.4 Temperature:** Be certain that fluid and ambient temperatures, both steady and transient, do not exceed the limitations of the hose. Temperatures below and above the recommended limit can degrade hose to a point where a failure may occur and release fluid. Care must be taken when routing hose near hot objects (e.g. manifolds) to properly insulate and protect the hose. Fire sleeve is not intended as insulation.
- 2.5 Fluid Compatibility:** Hose selection must assure compatibility of the hose tube, cover, reinforcement, and fittings with the fluid media used. Actual service life can only be determined by the end user by history or testing under all extreme conditions and other analysis.
- 2.6 Permeation:** Permeation (that is, seepage through the hose) may occur from inside the hose to outside when hose is used with gases, liquid and gas fuels, and refrigerants (including but not limited to such materials as helium, fuel oil, natural gas, or refrigerant). This permeation may result in high concentrations of vapors, which are potentially flammable, explosive, or toxic, and in loss of fluid. Dangerous explosions, fires, and other hazards can result when using the wrong hose for such applications. The system designer must take into account the fact that this permeation will take place and must not use hose if this permeation could be hazardous. The system designer must take into account all legal, government, insurance, or any other special regulations, which govern the use of fuels and refrigerants. Never use a hose even though the fluid compatibility is acceptable without considering the potential hazardous effects that can result from permeation through the hose assembly.
- Gaseous permeation, particularly through a PTFE hose, occurs primarily if the gas is "stored" at pressure in the hose. Most standards limit the amount of permissible permeation.**
- 2.7 Size:** Transmission of power by means of pressurized fluid varies with pressure and rate of flow. The size of the components must be adequate to keep pressure losses to a minimum, and avoid damage due to heat generation or excessive fluid velocity.
- 2.8 Routing: Attention** must be given to optimum routing to minimize inherent problems (kinking or flow restriction due to hose collapse). See SAE AIR1569 for further information.
- 2.9 Environment:** Care must be taken to insure that the hose and fittings are either compatible with or protected from the environment (that is, surrounding conditions) to which they are exposed. Environmental conditions including but not limited to ultraviolet radiation, sunlight, heat, ozone, moisture, water, salt water, chemicals and air pollutants can cause degradation and premature failure.
- 2.10 Mechanical Loads:** External forces can significantly reduce hose life or cause failure. Mechanical loads, which must be considered, include excessive flexing, twist, kinking, tensile or side loads, bend radius, and vibration. Use of swivel type fittings or adapters may be required to insure no twist is put into the hose. Unusual applications may require special testing prior to hose selection.
- 2.11 Physical Damage:** Care must be taken to protect hose from wear, snagging and cutting, which can cause premature hose failure. See SAE ARP1658 for Visual Guide.
- 2.12 Proper End Fitting:** See instructions 3.2 through 3.5 below. Testing to industry standards such as MIL-A-5070, AS1339, J517, etc must substantiate these recommendations.
- 2.13 Length:** When establishing a proper hose length, motion absorption, hose length changes due to pressure, and hose and machine tolerances must be considered.

- 2.14 Specifications and Standards:** When selecting hose and fittings, government, industry, and Parker specifications and recommendations must be reviewed and followed as applicable.
- 2.15 Hose Cleanliness:** Hose components may vary in cleanliness levels. Care must be taken to insure that the assembly selected has an adequate level of cleanliness and compatibility for the application. See SAE AS611 for PTFE hose assembly cleanliness levels.
- 2.16 Fire Resistant Fluids:** Some fire resistant fluids require the same hose as petroleum oil. Some use a special hose, while a few fluids will not work with any hose at all. See instructions 2.5 and 1.5. The wrong hose may fail after a very short service. In addition, all liquids but pure water may burn fiercely under certain conditions, and even pure water leakage may be hazardous.
- 2.17 Radiant Heat:** Hose can be heated to destruction without contact by such nearby items as hot manifolds or molten metal. The same heat source may then initiate a fire. This can occur despite the presence of cool air around the hose.
- 2.18 Welding or Brazing:** When using a torch or arc-welder in close proximity to hydraulic lines, the hydraulic lines should be removed or shielded with appropriate fire resistant materials. Flame or weld spatter could burn through the hose and possibly ignite escaping fluid resulting in a catastrophic failure. Heating of plated parts, including hose fittings and adapters, above 450° F (232° C) such as during welding, brazing, or soldering may emit deadly gases.
- 2.19 Atomic Radiation:** Atomic radiation affects all materials used in hose assemblies. Since The long-term effects may be unknown, do not expose hose assemblies to atomic radiation.
- 3.0 HOSE AND FITTING ASSEMBLY AND INSTALLATION INSTRUCTIONS**
- 3.1 Pre-Installation and Periodic Inspection:** Prior to installation, a careful examination of the hose assembly must be performed. All components must be checked for correct style, size, part number, length, and minimum bend radius. In addition, the hose must be examined for cleanliness, broken wires, cuts, kinks, obstructions, blisters, cover looseness, or any other visible defects. Do not use any hose that has any of these conditions. See SAE ARP1658 for illustrations of damage conditions.
- 3.2 Hose and Fitting Assembly:** Do not assemble a Parker fitting on a Parker hose that is not specifically listed by Parker for that fitting unless authorized in writing by the Engineering/Technical Manager or Chief Engineer of the appropriate Parker division. Do not assemble a Parker fitting on another manufacturer's hose or a Parker hose to another manufacturer's fitting unless: (i) the Engineering/Technical Manager or Chief Engineer of the appropriate Parker division approves the assembly in writing, (ii) the user verifies the assembly and the application through analysis and testing or (iii) fabricating MILSPEC assemblies in accordance with proper instructions. See instruction 1.4 above.
The Parker published instructions must be followed for assembling the fitting on the hose. These instructions are provided in the Parker fitting catalog for the specific Parker industrial fitting being used; most MILSPEC and Aerospace fitting to hose fabrication is closely controlled to authorized facilities.
- 3.3 Related Accessories:** Do not crimp or swage any Parker hose or fittings with anything but the proper listed Parker swage or crimp machine and dies and in accordance with Parker published instructions. Do not crimp or swage another manufacturer's hose fitting with a Parker crimp or swage die unless authorized in writing by the chief engineer of the appropriate Parker division.
- 3.4 Parts:** Do not use any Parker hose fitting part (including but not limited to socket, shell, nipple, or insert) except with the correct Parker mating parts, in accordance with Parker published instructions, unless authorized in writing by the Engineering/Technical Manager or Chief Engineer of the appropriate Parker division. Do not use hose or fitting components from Parker Stratoflex Division with any hose or fitting components from any other Parker Division without this specific authorization. SPD and HPD fitting components shall not be mixed.
- 3.5 Reusable/Permanent:** Do not reuse any reusable fitting product that blew off or pulled off a hose. Do not reuse any fitting component that is cracked or deformed beyond new part tolerance. Do not reuse hose. Do not reuse a Parker permanent (that is, crimped or swaged) hose fitting or any part thereof.
- 3.6 Minimum Bend Radius:** Installation of a hose at less than the minimum listed bend radius may significantly reduce the hose life and cause premature failure. Particular attention must be given to preclude sharp bending at the hose/fitting juncture. If any Stratoflex Products Division hose has been bent to any radius less than its minimum bend radius (minor exceptions from proper authority) or has been kinked during installation, do not use such hose. Such hose is damaged and cannot be used and should be discarded.
- 3.7 Twist Angle and Orientation:** Hose installations must be such that relative motion of machine components does not produce twisting. No twist in the hose is permitted during installation or use. See SAE AIR1569 for additional information.
- 3.8 Securement:** In many applications, it may be necessary to restrain, protect, or guide the hose to protect it from damage by unnecessary flexing, pressure surges, and contact with other mechanical components. Care must be taken to insure such restraints do not introduce additional stress or wear points.
- 3.9 Proper Connection of Ports:** Proper physical installation of the hose requires a correctly installed port connection insuring that no twist or torque is transferred to the hose confirm proper fabrication of the assembly. Gaseous test, including air-under-water, shall be at rated working pressure only and see 4.7 caution below. Care must be exercised to prevent water, or other fluid contaminants from unnecessarily contacting reinforcement, etc.
- 3.10 External Damage:** Proper installation is not complete without insuring that tensile loads, side loads, kinking, flattening, potential abrasion, thread damage, or damage to sealing surfaces are corrected or eliminated. See instruction 2.10.
- 3.11 System Checkout:** All air entrapment must be eliminated (see 4.7) and the system pressurized to the maximum systems pressure and checked for proper function and freedom from leaks. Personnel must stay out of potential hazardous areas while testing and using.
- 3.12 Routing:** Hose should be routed in such a manner so if a failure does occur, oil or fuel mist will not come into contact with hot surfaces, open flame, or sparks, and the chance of personal injury is minimized.
- 4.0 HOSE AND FITTING INSPECTION INSTRUCTIONS**
- 4.1** Even with proper selection and installation, hose life may be significantly reduced without a continuing inspection program. The frequency of inspection should be determined by the system designer or end user taking into account the severity of the application and risk potential. An inspection program must be established and followed by the user and, at minimum, must include instructions 4.2 through 4.7, listed below.
- 4.2 Visual Inspection Hose/Fitting:** Any of the following conditions require immediate shut down and replacement of the hose assembly: (See also ARP1658 for illustrations.)
- Fitting slippage on hose,
 - Damaged, cut or abraded cover (any reinforcement exposed);
 - Hard, stiff, heat cracked, or charred hose;
 - Cracked, damaged, or badly corroded hose or fittings;
 - Leaks at fitting or in hose;
 - Kinked, crushed, flattened or twisted hose; and
 - Blistered, soft, degraded, or loose cover.
- System malfunction including but not limited to, over-pressurization or pressure spikes.
- 4.3 Visual Inspection All Other:** The following items must be tightened, repaired or replaced as required:
- Leaking port conditions;
 - Remove excess dirt buildup;
 - Clamps, guards, shields; and
 - System fluid level, fluid type and any air entrapment.
- 4.4 Functional Test:** Operate the system at maximum operating pressure and check for possible malfunctions and freedom from leaks. Personnel must avoid potential hazardous areas while testing and using the system.
- 4.5 Replacement Intervals:** Specific replacement intervals must be considered based on previous service life, government or industry recommendations, or when failures could result in unacceptable downtime, damage, or injury risk. See instructions 1.2 and 4.2 above.
- 4.6 Inspecting a Pressurized System:** Hydraulic power is accomplished by utilizing high-pressure fluids to do work. Hoses, fittings, and hose assemblies all contribute to doing work by transmitting fluids at high pressures. Fluids under pressure can be dangerous and potentially lethal and, therefore, extreme caution must be exercised when working with fluids under pressure and handling the hoses transporting the fluids. From time to time, hose assemblies will fail. Usually those failures are the result of some form of misapplication, abuse, or simply wear. When hoses fail, generally the high-pressure fluids inside escape in some sort of stream which may or may not be visible to the user. Under no circumstances should the user attempt to locate the leak by "feeling" with their hands or any other part of their body. High-pressure fluids can and will penetrate the skin and cause severe tissue damage and possibly loss of limb. Even seemingly minor hydraulic fluid injection injuries must be treated by a physician with knowledge of the tissue damaging properties of hydraulic fluid.
If a hose failure occurs, immediately shut down the equipment and leave the area until pressure has been completely released from the hose assembly. Simply shutting down the hydraulic pump may or may not eliminate the pressure in the hose assembly. Many times check valves, etc., are employed in a system and can cause pressure to remain in a hose assembly even when pumps or equipment are not operating. Tiny holes in the hose, commonly known as pinholes, can eject small, dangerously powerful but hard to see streams of hydraulic fluid. It may take several minutes or even hours for the pressure to be relieved so that the hose assembly may be examined safely.
Once the pressure has been reduced to zero, the hose assembly may be taken off the equipment and examined. It must always be replaced if a failure has occurred. Never attempt to patch or repair a hose assembly that has failed. Consult the nearest Parker distributor or the appropriate Parker division for hose assembly replacement information.
Never touch or examine a failed hose assembly unless it is obvious that the hose no longer contains fluid under pressure. The high-pressure fluid is extremely dangerous and can cause serious and potentially fatal injury.
- 4.7 Gases:** Special care should be taken when working with gaseous systems. Gases are compressible, thus increase the danger of over-pressure, particularly during test. Sudden escape of gases can cause blindness if the escaping gases contact the eye and can cause freezing or other severe injuries if it contacts any other portion of the body.

Offer of Sale

The items described in this document are hereby offered for sale at prices to be established by Parker Hannifin Corporation, its subsidiaries and its authorized distributors. This offer and its acceptance by any customer ("Buyer") shall be governed by all of the following Terms and Conditions. Buyer's order for any item described in its document, when communicated to Parker Hannifin Corporation, its subsidiary or an authorized distributor ("Seller") verbally or in writing, shall constitute acceptance of this offer.

1. **Terms and Conditions of Sale:** All descriptions, quotations, proposals, offers, acknowledgments, acceptances and sales of Seller's products are subject to and shall be governed exclusively by the terms and conditions stated herein. Buyer's acceptance of any offer to sell is limited to these terms and conditions. Any terms or conditions in addition to, or inconsistent with those stated herein, proposed by Buyer in any acceptance of an offer by Seller, are hereby objected to. No such additional, different or inconsistent terms and conditions shall become part of the contract between Buyer and Seller unless expressly accepted in writing by Seller. Seller's acceptance of any offer to purchase by Buyer is expressly conditional upon Buyer's assent to all the terms and conditions stated herein, including any terms in addition to, or inconsistent with those contained in Buyer's offer. Acceptance of Seller's products shall in all events constitute such assent.

2. **Payment:** Payment shall be made by Buyer net 30 days from the date of delivery of the items purchased hereunder. Any claims by Buyer for omissions or shortages in a shipment shall be waived unless Seller receives notice thereof within 30 days after Buyer's receipt of the shipment.

3. **Delivery:** Unless otherwise provided on the face hereof, delivery shall be made F.O.B. Seller's plant. Regardless of the method of delivery, however, risk of loss shall pass to Buyer upon Seller's delivery to a carrier. Any delivery dates shown are approximate only and Seller shall have no liability for any delays in delivery.

4. **Warranty:** Seller warrants that the items sold hereunder shall be free from defects in material or workmanship for a period of 365 days from the date of shipment to Buyer, or 2,000 hours of use, whichever expires first. THIS WARRANTY COMPRISES THE SOLE AND ENTIRE WARRANTY PERTAINING TO ITEMS PROVIDED HEREUNDER. SELLER MAKES NO OTHER WARRANTY, GUARANTEE, OR REPRESENTATION OF ANY KIND WHATSOEVER. ALL OTHER WARRANTIES, INCLUDING BUT NOT LIMITED TO, MERCHANTABILITY AND FITNESS FOR PURPOSE, WHETHER EXPRESS, IMPLIED, OR ARISING BY OPERATION OF LAW, TRADE USAGE, OR COURSE OF DEALING ARE HEREBY DISCLAIMED. NOTWITHSTANDING THE FOREGOING, THERE ARE NO WARRANTIES WHATSOEVER ON ITEMS BUILT OR ACQUIRED WHOLLY OR PARTIALLY, TO BUYER'S DESIGNS OR SPECIFICATIONS.

5. **Limitation Of Remedy:** SELLER'S LIABILITY ARISING FROM OR IN ANY WAY CONNECTED WITH THE ITEMS SOLD OR THIS CONTRACT SHALL BE LIMITED EXCLUSIVELY TO REPAIR OR REPLACEMENT OF THE ITEMS SOLD OR REFUND OF THE PURCHASE PRICE PAID BY BUYER, AT SELLER'S SOLE OPTION. IN NO EVENT SHALL SELLER BE LIABLE FOR ANY INCIDENTAL, CONSEQUENTIAL OR SPECIAL DAMAGES OF ANY KIND OR NATURE WHATSOEVER, INCLUDING BUT NOT LIMITED TO LOST PROFITS ARISING FROM OR IN ANY WAY CONNECTED WITH THIS AGREEMENT OR ITEMS SOLD HEREUNDER, WHETHER ALLEGED TO ARISE FROM BREACH OF CONTRACT, EXPRESS OR IMPLIED WARRANTY, OR IN TORT, INCLUDING WITHOUT LIMITATION, NEGLIGENCE, FAILURE TO WARN OR STRICT LIABILITY.

6. **Changes, Reschedules and Cancellations:** Buyer may request to modify the designs or specifications for the items sold hereunder as well as the quantities and delivery dates thereof, or may request to cancel all or part of this order, however, no such requested modification or cancellation shall become part of the contract between Buyer and Seller unless accepted by Seller in a written amendment to this Agreement. Acceptance of any such requested modification or cancellation shall be at Seller's discretion, and shall be upon such terms and conditions as Seller may require.

7. **Special Tooling:** A tooling charge may be imposed for any special tooling, including without limitation, dies, fixtures, molds and patterns, acquired to manufacture items sold pursuant to this contract. Such special tooling shall be and remain Seller's property notwithstanding payment of any charges by Buyer. In no event will Buyer acquire any interest in apparatus belonging to Seller which is utilized in the manufacture of the items sold hereunder, even if such apparatus has been specially converted or adapted for such manufacture and notwithstanding any charges paid by Buyer. Unless otherwise agreed, Seller shall have the right to alter, discard or otherwise dispose of any special tooling or other property in its sole discretion at any time.

8. **Buyer's Property:** Any designs, tools, patterns, materials, drawings, confidential information or equipment furnished by Buyer or any other items which become Buyer's property, may be considered obsolete and may be destroyed by Seller after two (2) consecutive years have elapsed without Buyer placing an order for the items which are manufactured using such property. Seller shall not be responsible for any loss or damage to such property while it is in Seller's possession or control.

9. **Taxes:** Unless otherwise indicated on the face hereof, all prices and charges are exclusive of excise, sales, use, property, occupational or like taxes which may be imposed by any taxing authority upon the manufacture, sale or delivery of the items sold hereunder. If any such taxes must be paid by Seller or if Seller is liable for the collection of such tax, the amount thereof shall be in addition to the amounts for the items sold. Buyer agrees to pay all such taxes or to reimburse Seller therefore upon receipt of its invoice. If Buyer claims exemption from any sales, use or other tax imposed by any taxing authority, Buyer shall save Seller harmless from and against any such tax, together with any interest or penalties thereon which may be assessed if the items are held to be taxable.

10. **Indemnity For Infringement of Intellectual Property Rights:** Seller shall have no liability for infringement of any patents, trademarks, copyrights, trade dress, trade secrets or similar rights except as provided in this Part 10. Seller will defend and indemnify Buyer against allegations of infringement of U.S. patents, U.S. trademarks, copyrights, trade dress and trade secrets (hereinafter 'Intellectual Property Rights'). Seller will defend at its expense and will pay the cost of any settlement or damages awarded in an action brought against Buyer based on an allegation that an item sold pursuant to this contract infringes the Intellectual Property Rights of a third party. Seller's obligation to defend and indemnify Buyer is contingent on Buyer notifying Seller within ten (10) days after Buyer becomes aware of such allegations of infringement, and Seller having sole control over the defense of any allegations or actions including all negotiations for settlement or compromise. If an item sold hereunder is subject to a claim that it infringes the Intellectual Property Rights of a third party, Seller may, at its sole expense and option, procure for Buyer the right to continue using said item, replace or modify said item so as to make it noninfringing, or offer to accept return of said item and return the purchase price less a reasonable allowance for depreciation. Notwithstanding the foregoing, Seller shall have no liability for claims of infringement based on information provided by Buyer, or directed to items delivered hereunder for which the designs are specified in whole or part by Buyer, or infringements resulting from the modification, combination or use in a system of any item sold hereunder. The foregoing provisions of this Part 10 shall constitute Seller's sole and exclusive liability and Buyer's sole and exclusive remedy for infringement of Intellectual Property Rights.

If a claim is based on information provided by Buyer or if the design for an item delivered hereunder is specified in whole or in part by Buyer, Buyer shall defend and indemnify Seller for all costs, expenses or judgments resulting from any claim that such item infringes any patent, trademark, copyright, trade dress, trade secret or any similar right.

11. **Force Majeure:** Seller does not assume the risk of and shall not be liable for delay or failure to perform any of Seller's obligations by reason of circumstances beyond the reasonable control of Seller (hereinafter 'events of Force Majeure'). Events of Force Majeure shall include without limitation, accidents, acts of God, strikes or labor disputes, acts, laws, rules or regulations of any government or government agency, fires, floods, delays or failures in delivery of carriers or suppliers, shortages of materials and any other cause beyond Seller's control.

12. **Entire Agreement/Governing Law:** The terms and conditions set forth herein, together with any amendments, modifications and any different terms or conditions expressly accepted by Seller in writing, shall constitute the entire Agreement concerning the items sold, and there are no oral or other representations or agreements which pertain thereto. This Agreement shall be governed in all respects by the law of the State of Ohio. No actions arising out of the sale of the items sold hereunder or this Agreement may be brought by either party more than two (2) years after the cause of action accrues.



Dynatube[®] Fittings

NOTES:

About Parker Hannifin Corporation

Markets:

- ▶ Agriculture
- ▶ Aviation/Aerospace
- ▶ Food & Beverage
- ▶ Industrial Machinery
- ▶ In-Plant Automotive
- ▶ Machine Tool
- ▶ Marine
- ▶ Life Sciences/
Pharmaceutical
Processing
- ▶ Mobile
- ▶ Oil & Gas
- ▶ Packaging
- ▶ Power Generation
& Energy
- ▶ Process
- ▶ Pulp & Paper
- ▶ Refrigeration, Heating
& Air Conditioning
- ▶ Semiconductor
- ▶ Telecommunications/
Information Technology
- ▶ Transportation

Product Information

Parker's products are vital to virtually everything that moves or requires control, including the manufacture and processing of raw materials, durable goods, infrastructure development and all forms of transport. Customers seeking product information, distributor locations, or repair services will receive prompt attention by calling the Parker Information Center using our toll free numbers.

United States:
1-800-C-Parker
(1-800-272-7537)
www.parker.com

In Europe:
00800-C-PARKER-H
(00800-2727-5374)
from AU, BE, CH, DE, EI, FR, UK
only.

For other countries call
+44 1442 358429
Email: epic@parker.com
Fax: +44 1442 458112
www.parker.com/eu

Throughout the world, Parker is serving more than 400,000 customers to improve productivity and reliability in thousands of industries. Parker motion and control systems are in operation on satellites orbiting the Earth, in machine tools and mobile equipment, on oil rigs and refineries, in hospitals and laboratories, in fact, wherever there's a need for motion and control, you'll find Parker components and system solutions hard at work. For more information, visit Parker's web site at www.parker.com.

Aerospace



Control systems and components for aerospace and related high-technology markets

Automation

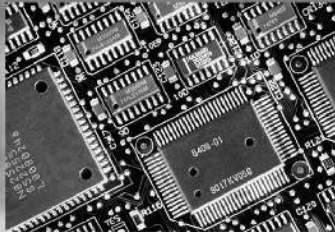

Pneumatic and electro-mechanical components and systems for automation

Filtration



Commercial filtration, separation and clarification products

Fluid Connectors



Rigid and flexible connectors and associated products for pneumatic and fluid systems

Climate & Industrial Controls



System-control and fluid handling components and systems for refrigeration, air conditioning and industrial equipment

Instrumentation



High-quality critical flow components for process instrumentation, ultra-high-purity, medical and analytical applications

Hydraulics



Hydraulic components and systems for industrial and mobile machinery

Seal



Industrial and commercial sealing devices and related products

Parker
anything possible

Stratoflex Products Division
Headquarters
Parker Aerospace Group
Parker Hannifin Corporation
220 Roberts Cut-Off Road
Fort Worth, Texas 76114 U.S.A.
Phone: (817) 738-6543
Fax: (817) 738-9920

Stratoflex Products Division
Couplings Business Unit
3800 Calle Tecate
Camarillo, CA 93012 U.S.A.
Phone: (805) 484-8533
Fax: (805) 987-8958

Stratoflex Products Division
Jacksonville Business Unit
2725 W. 5th Street
Jacksonville, Florida 32254 U.S.A.
Phone: (904) 389-3400
Fax: (904) 384-5874

Website: www.parker.com/stratoflex

